



Agency Approvals

AGENCY AGENCY FILE NUMBER



E183209



R50119118

Description

The 1812L Series device provides surface mount overcurrent protection for applications where resettable protection is desired.



Features

- RoHS compliant and lead-free
- Fast response to fault currents
- Compact design saves board space
- Low resistance
- Low-profile
- Compatible with high temperature solders

Applications

- Plug and play protection for motherboards and peripherals
- USB peripherals
- PCI cards
- Game console port protection

Electrical Characteristics

Part Number*	Marking	I _{hold} (A)	I _{trip} (A)	V _{max} (Vdc)	I _{max} (A)	P _d max. (W)	Maximum Time To Trip		Resistance			Agency Approvals	
							Current (A)	Time (Sec.)	R _{min} (Ω)	R _{typ} (Ω)	R _{1max} (Ω)		
1812L010	LF010	0.10	0.30	30	100	0.8	0.50	1.50	1.600	7.000	15.000	X	X
1812L014	LF014	0.14	0.34	60	10	0.8	1.50	0.15	1.500	4.000	6.000	X	X
1812L020	LF020	0.20	0.40	30	100	0.8	8.00	0.02	0.800	2.900	5.000	X	X
1812L050-C	LF050	0.50	1.00	15	100	0.8	8.00	0.15	0.150	0.600	1.000	X	X
1812L075-C	LF075	0.75	1.50	13.2	100	0.8	8.00	0.20	0.100	0.260	0.450	X	X
1812L075/24	LF075-24	0.75	1.50	24	100	0.8	8.00	0.20	0.110	0.200	0.290	X	X
1812L075/33	LF075-33	0.75	1.50	33	20	0.8	8.00	0.20	0.110	0.260	0.400	X	X
1812L110-C	LF110	1.10	2.20	6	100	0.8	8.00	0.30	0.040	0.120	0.210	X	X
1812L110/16	LF110-16	1.10	1.95	16	100	0.8	8.00	0.50	0.060	0.120	0.180	X	X
1812L110/33	LF110-33	1.10	1.95	33	20	0.8	8.00	0.50	0.060	0.120	0.200	X	X
1812L125-C	LF125	1.25	2.50	15	100	0.8	8.00	0.40	0.050	0.160	0.250	X	X
1812L125/6	LF125-6	1.25	2.50	6	100	0.8	8.00	0.40	0.050	0.090	0.140	X	X
1812L150-C	LF150	1.50	3.00	8	100	0.8	8.00	0.30	0.040	0.070	0.110	X	X
1812L150/12	LF150-12	1.50	3.00	12	100	0.8	8.00	0.50	0.040	0.070	0.110	X	X
1812L150/24	LF150-24	1.50	3.00	24	20	0.8	8.00	1.50	0.040	0.070	0.120	X	X
1812L160-C	LF160	1.60	2.80	8	100	0.8	8.00	1.00	0.030	0.066	0.100	X	X
1812L160/12	LF160-12	1.60	2.80	12	100	0.8	8.00	1.00	0.030	0.066	0.100	X	X
1812L200-C	LF200	2.00	3.50	8	100	0.8	8.00	2.00	0.020	0.040	0.060	X	X
1812L260-C	LF260	2.60	5.00	6	100	0.8	8.00	2.50	0.015	0.030	0.047	X	X

I_{hold} = Hold current: maximum current device will pass without tripping in 20°C still air.

I_{trip} = Trip current: minimum current at which the device will trip in 20°C still air.

V_{max} = Maximum voltage device can withstand without damage at rated current (I_{max})

I_{max} = Maximum fault current device can withstand without damage at rated voltage (V_{max})

P_d = Power dissipated from device when in the tripped state at 20°C still air.

R_{min} = Minimum resistance of device in initial (un-soldered) state.

R_{typ} = Typical resistance of device in initial (un-soldered) state.

R_{1max} = Maximum resistance of device at 20°C measured one hour after tripping or reflow soldering of 260°C for 20 sec.

Caution: Operation beyond the specified rating may result in damage and possible arcing and flame.

***Note:** Some devices in this product series may have "-C" in the Part Number. The "-C" should be omitted when placing orders for the device.

Temperature Derating

Part Number*	Ambient Operation Temperature								
	-40°C	-20°C	0°C	23°C	40°C	50°C	60°C	70°C	85°C
	Hold Current (A)								
1812L010	0.16	0.14	0.12	0.10	0.08	0.07	0.06	0.05	0.03
1812L014	0.23	0.19	0.17	0.14	0.12	0.10	0.09	0.08	0.06
1812L020	0.29	0.26	0.23	0.20	0.17	0.15	0.14	0.12	0.10
1812L050-C	0.77	0.68	0.59	0.50	0.44	0.40	0.37	0.33	0.29
1812L075-C	1.15	1.01	0.88	0.75	0.65	0.60	0.55	0.49	0.43
1812L075/24	1.06	0.95	0.84	0.75	0.60	0.55	0.50	0.45	0.37
1812L075/33	1.10	1.00	0.88	0.75	0.66	0.60	0.56	0.47	0.36
1812L110-C	1.59	1.43	1.26	1.10	0.95	0.87	0.80	0.71	0.60
1812L110/16	1.58	1.43	1.27	1.10	0.95	0.85	0.77	0.71	0.58
1812L110/33	1.55	1.40	1.25	1.10	0.93	0.83	0.73	0.63	0.50
1812L125-C	2.00	1.75	1.52	1.25	1.00	0.95	0.90	0.75	0.53
1812L125/6	2.00	1.75	1.52	1.25	1.00	0.95	0.90	0.75	0.53
1812L150-C	2.06	1.93	1.79	1.50	1.28	1.10	1.02	0.80	0.68
1812L150/12	2.04	1.88	1.68	1.50	1.25	1.10	1.00	0.80	0.60
1812L150/24	2.05	1.87	1.67	1.50	1.25	1.08	0.95	0.77	0.60
1812L160-C	2.20	2.06	1.91	1.60	1.36	1.17	1.09	0.85	0.72
1812L160/12	2.18	2.01	1.79	1.60	1.34	1.16	1.07	0.83	0.60
1812L200-C	3.08	2.71	2.35	2.00	1.80	1.60	1.50	1.07	0.80
1812L260-C	4.00	3.52	3.06	2.60	2.34	2.08	1.95	1.39	1.04

*Note: Some devices in this product series may have "-C" in the Part Number. The "-C" should be omitted when placing orders for the device.

Temperature Derating Curve

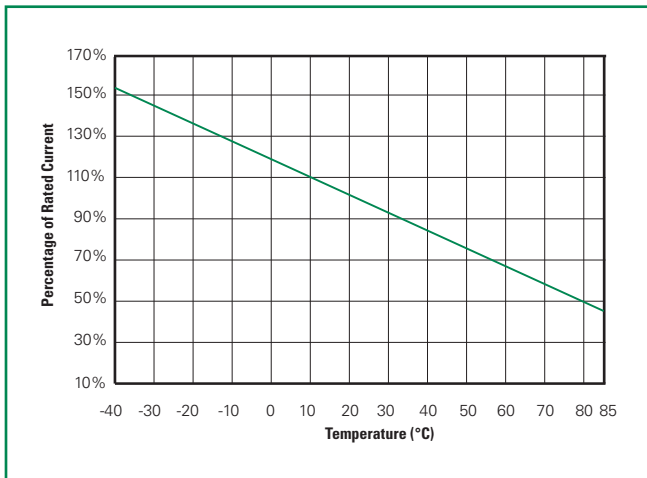

Average Time Current Curves

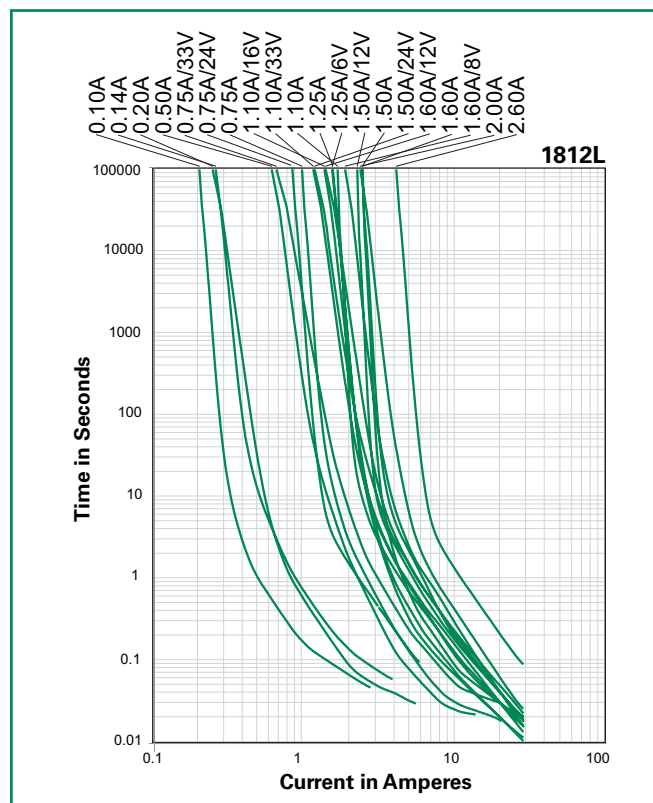

The average time current curves and Temperature Derating curve performance is affected by a number of variables, and these curves provided as guidance only. Customer must verify the performance in their application.

Physical Specifications

Terminal Material	Solder-Plated Copper (Solder Material: Matte Tin (Sn))
Lead Solderability	Meets EIA Specification RS186-9E, ANSI/J-STD-002 Category 3.

Environmental Specifications

Operating/Storage Temperature	-40°C to +85°C
Maximum Device Surface Temperature in Tripped State	125°C
Passive Aging	+85°C, 1000 hours -/+5% typical resistance change
Humidity Aging	+85°C, 85% R.H., 1000 hours -/+5% typical resistance change
Thermal Shock	MIL-STD-202, Method 107G +85°C/-40°C 20 times -30% typical resistance change
Solvent Resistance	MIL-STD-202, Method 215 No change
Vibration	MIL-STD-883C, Method 2007.1, Condition A No change
Moisture Level Sensitivity	Level 2, J-STD-020C

Soldering Parameters

Condition	Reflow
Peak Temp/ DurationTime	260°C / 10 Sec
Time above liquids (TAL) 220°C	60 Sec ~ 100 Sec
Preheat 120°C~ 180°C	50 Sec ~ 150 Sec
Storage Condition	0°C~35°C, ≤70%RH

- Recommended reflow methods: IR, vapor phase oven, hot air oven, N₂ environment for lead-free
- Recommended maximum paste thickness is 0.25mm (0.010 inch)
- Devices can be cleaned using standard industry methods and solvents.

Note: If reflow temperatures exceed the recommended profile, devices may not meet the performance requirements.

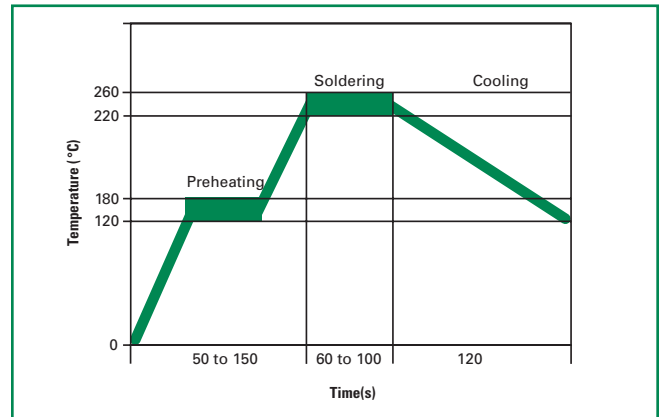

Dimensions

MARKING CODE VARIES
WITH AMPERAGE AND VOLTAGE RATING
(See Electrical Characteristics Table)
SHOWN ARE:
- 1.1A/6V RATING (LEFT)
- 1.1A/33V RATING (RIGHT)

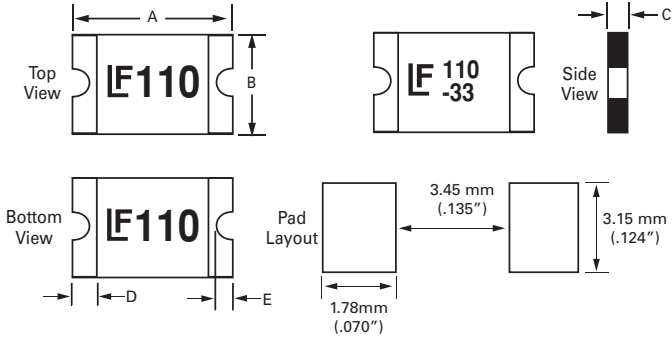

Part Number*	A				B				C				D		E			
	Inches		mm		Inches		mm		Inches		mm		Inches	mm	Inches		mm	
	Min.	Max.	Min.	Max.	Min.	Max.	Min.	Max.	Min.	Max.	Min.	Max.	Min.	Max.	Min.	Max.	Min.	Max.
1812L010	0.17	0.19	4.37	4.73	0.12	0.13	3.07	3.41	0.03	0.05	0.75	1.25	0.01	0.30	0.01	0.03	0.25	0.65
1812L014	0.17	0.19	4.37	4.73	0.12	0.13	3.07	3.41	0.03	0.08	0.75	1.95	0.01	0.30	0.01	0.03	0.25	0.65
1812L020	0.17	0.19	4.37	4.73	0.12	0.13	3.07	3.41	0.02	0.04	0.55	1	0.01	0.30	0.01	0.03	0.25	0.65
1812L050-C	0.17	0.19	4.37	4.73	0.12	0.13	3.07	3.41	0.02	0.03	0.5	0.75	0.01	0.30	0.01	0.02	0.25	0.5
1812L075-C	0.17	0.19	4.37	4.73	0.12	0.13	3.07	3.41	0.02	0.03	0.5	0.75	0.01	0.30	0.01	0.02	0.25	0.5
1812L075/24	0.17	0.19	4.37	4.73	0.12	0.13	3.07	3.41	0.03	0.06	0.75	1.55	0.01	0.30	0.01	0.03	0.25	0.65
1812L075/33	0.17	0.19	4.37	4.73	0.12	0.13	3.07	3.41	0.03	0.06	0.75	1.55	0.01	0.30	0.01	0.03	0.25	0.65
1812L110-C	0.17	0.19	4.37	4.73	0.12	0.13	3.07	3.41	0.02	0.03	0.5	0.71	0.01	0.30	0.01	0.02	0.25	0.5
1812L110/16	0.17	0.19	4.37	4.73	0.12	0.13	3.07	3.41	0.03	0.05	0.75	1.25	0.01	0.30	0.01	0.03	0.25	0.65
1812L110/33	0.17	0.19	4.37	4.73	0.12	0.13	3.07	3.41	0.05	0.08	1.2	2	0.01	0.30	0.01	0.03	0.25	0.65
1812L125-C	0.17	0.19	4.37	4.73	0.12	0.13	3.07	3.41	0.03	0.05	0.75	1.25	0.01	0.30	0.01	0.02	0.25	0.5
1812L125/6	0.17	0.19	4.37	4.73	0.12	0.13	3.07	3.41	0.02	0.03	0.45	0.75	0.01	0.30	0.01	0.03	0.25	0.65
1812L150-C	0.17	0.19	4.37	4.73	0.12	0.13	3.07	3.41	0.02	0.03	0.4	0.71	0.01	0.30	0.01	0.03	0.25	0.65
1812L150/12	0.17	0.19	4.37	4.73	0.12	0.13	3.07	3.41	0.03	0.05	0.75	1.25	0.01	0.30	0.01	0.03	0.25	0.65
1812L150/24	0.17	0.19	4.37	4.73	0.12	0.13	3.07	3.41	0.03	0.07	0.8	1.8	0.01	0.30	0.01	0.03	0.25	0.65
1812L160-C	0.17	0.19	4.37	4.73	0.12	0.13	3.07	3.41	0.02	0.03	0.4	0.75	0.01	0.30	0.01	0.03	0.25	0.65
1812L160/12	0.17	0.19	4.37	4.73	0.12	0.13	3.07	3.41	0.03	0.05	0.75	1.25	0.01	0.30	0.01	0.03	0.25	0.65
1812L200-C	0.17	0.19	4.37	4.73	0.12	0.13	3.07	3.41	0.03	0.05	0.81	1.2	0.01	0.30	0.01	0.02	0.25	0.5
1812L260-C	0.17	0.19	4.37	4.73	0.12	0.13	3.07	3.41	0.03	0.05	0.8	1.34	0.01	0.30	0.01	0.02	0.25	0.5

*Note: Some devices in this product series may have "-C" in the Part Number. The "-C" should be omitted when placing orders for the device.

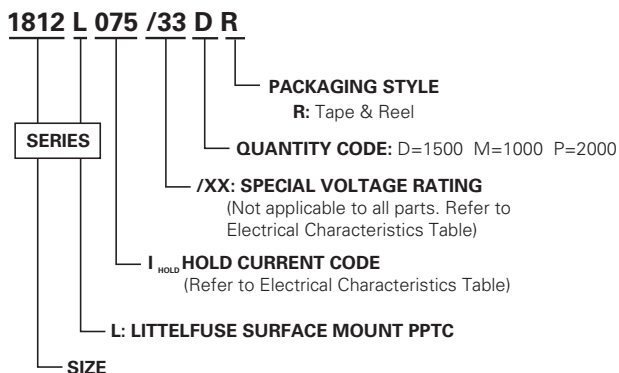
Part Ordering Number System*

Packaging

Part Number*	Ordering Number*	I _{hold} (A)	I _{hold} Code	Voltage Option	Packaging Option	Quantity	Quantity & Packaging Codes
1812L010	1812L010DR	0.10	010		Tape and Reel	1500	DR
1812L014	1812L014DR	0.14	014		Tape and Reel	1500	DR
1812L020	1812L020PR	0.20	020		Tape and Reel	2000	PR
1812L050-C	1812L050PR	0.50	050		Tape and Reel	2000	PR
1812L075-C	1812L075PR	0.75	075		Tape and Reel	2000	PR
1812L75/24	1812L75/24DR	0.75	075	/24	Tape and Reel	1500	DR
1812L75/33	1812L75/33DR	0.75	075	/33	Tape and Reel	1500	DR
1812L110-C	1812L110PR	1.10	110		Tape and Reel	2000	PR
1812L110/16	1812L110/16DR	1.10	110	/16	Tape and Reel	1500	DR
1812L110/33	1812L110/33MR	1.10	110	/33	Tape and Reel	1000	MR
1812L125-C	1812L125DR	1.25	125		Tape and Reel	1500	DR
1812L125/6	1812L125/6PR	1.25	125	/6	Tape and Reel	2000	PR
1812L150-C	1812L150ZR	1.50	150		Tape and Reel	2000	ZR
1812L150/12	1812L150/12DR	1.50	150	/12	Tape and Reel	1500	DR
1812L150/24	1812L150/24MR	1.50	150	/24	Tape and Reel	1000	MR
1812L160-C	1812L160PR	1.60	160		Tape and Reel	2000	PR
1812L160/12	1812L160/12DR	1.60	160	/12	Tape and Reel	1500	DR
1812L200-C	1812L200DR	2.00	200		Tape and Reel	1500	DR
1812L260-C	1812L260ZR	2.60	260		Tape and Reel	1000	ZR

*Note: Some devices in this product series may have "-C" in the Part Number. The "-C" should be omitted when placing orders for the device.

Tape and Reel Specifications

TAPE SPECIFICATIONS: EIA-481-1 (mm)			
	1812L020, 1812L050-C, 1812L075-C, 1812L110-C, 1812L125/6, 1812L150-C, 1812L160-C	1812L010, 1812L014, 1812L075/24, 1812L075/33, 1812L110/16, 1812L125-C, 1812L150/12, 1812L160/12, 1812L200-C	1812L110/33, 1812L150/24, 1812L260-C
W	12.00+0.30-0.10	12.00+/-0.30	12.00+/-0.30
F	5.50+/-0.05	5.50+/-0.05	5.50+/-0.05
E₁	1.75+/-0.10	1.75+/-0.10	1.75+/-0.10
D₀	1.50+0.10	1.55+/-0.05	1.55+/-0.05
D₁	1.50+0.25	1.50 (MIN)	1.50 (MIN)
P₀	4.00+/-0.10	4.00+/-0.10	4.00+/-0.10
P₁	8.00+/-0.10	8.00+/-0.10	8.00+/-0.10
P₂	2.00+/-0.05	2.00+/-0.05	2.00+/-0.05
A₀	3.58+/-0.10	3.58+/-0.10	3.58+/-0.10
B₀	4.93+/-0.10	4.93+/-0.10	4.93+/-0.10
T	0.25+/-0.10	0.25+/-0.10	0.25+/-0.10
K₀	1.02+/-0.10	1.30+/-0.10	2.10+/-0.10
<i>Leader min.</i>	390	390	390
<i>Trailer min.</i>	160	160	160

REEL DIMENSIONS: EIA-481-1 (mm)	
H	16.0+/-0.2
W	13.2+/-1.5
D	Ø 60.2+/-0.5
F	Ø13.0+/-0.5
C	Ø178+/-1.0
H₁	11+/-0.5
W₁	2.5+0.5
W₂	3.0+0.5
W₃	4.0+0.5
W₄	5.0+0.5

Tape and Reel Diagram

